



CMK系列快速接线端子
CMK SERIES PUSH IN QUICK-CONNECTORS

Material of connectors shell: Transparent polycarbonate

Material of conductive parts: Thinned copper

Material of contact springs: AISI 301 stainless steel

Rated voltage(V): 450V AC

Rated current(A): 24A









Connection capacity: 0.5-2.5mm²

Type of electric connection: Equipotential

Working temperature: -40°C to 85°C

Strip length: 11mm/0.43 Inch



| Product Code | Connector type | No. of circuits | Rigid wire mm ² | Volt (V) | Ampere (A) | Un  | Un  |
|--------------|---|-----------------|----------------------------|----------|------------|--|--|
| CMK-202 |  | 2 | 0.5→2.5 | 450 V | 24 A | 150 | 9000 |
| CMK-203 |  | 3 | | | | 100 | 6000 |
| CMK-204 |  | 4 | | | | 100 | 6000 |
| CMK-205 |  | 5 | | | | 100 | 6000 |
| CMK-206 |  | 6 | | | | 50 | 3000 |
| CMK-208 |  | 8 | | | | 50 | 3000 |

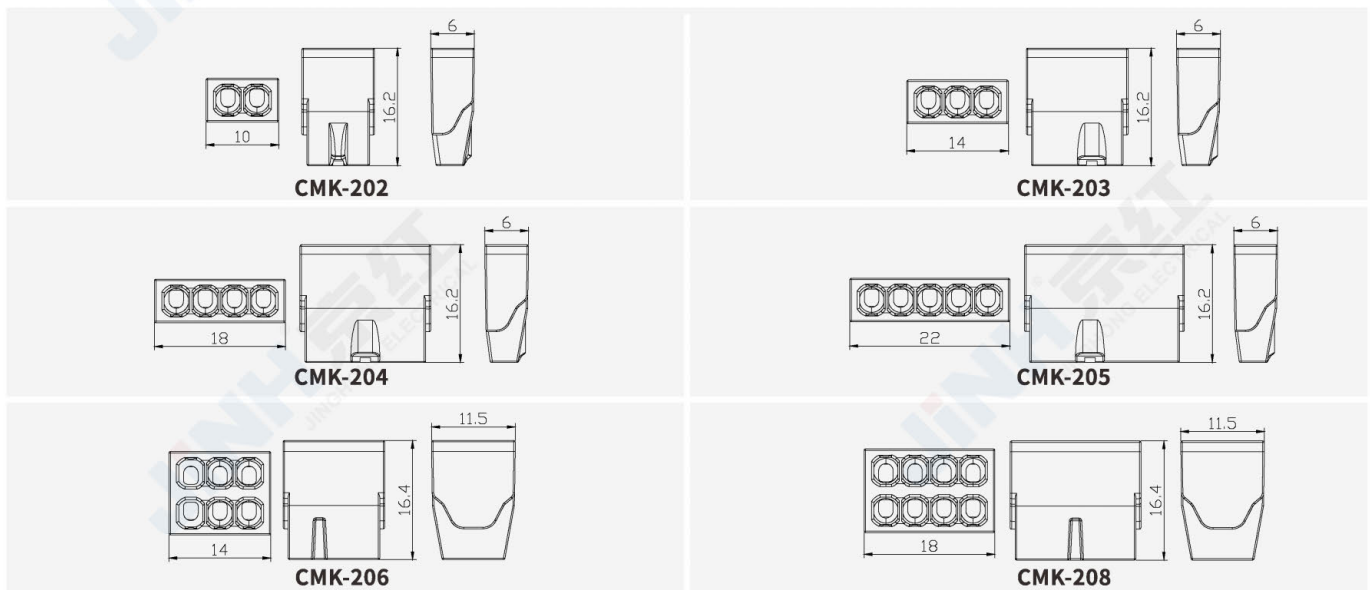



CMK系列快速接线端子
CMK SERIES PUSH IN QUICK-CONNECTORS

Material of connectors shell: Transparent polycarbonate

Material of conductive parts: Thinned copper

Material of contact springs: AISI 301 stainless steel

Rated voltage(V): 450V AC

Rated current(A): 24A

Connection capacity: 0.75-2.5mm²

Type of electric connection: Equipotential

Working temperature: -40°C to 85°C

Strip length: 11mm/0.43 Inch



| Product Code | Connector type | No. of circuits | Rigid wire mm ² | Volt (V) | Ampere (A) | Un | Un |
|--------------|----------------|-----------------|----------------------------|----------|------------|-----|------|
| CMK-252 | | 2 | 0.75→2.5 | 450 V | 24 A | 100 | 6000 |
| CMK-253 | | 3 | | | | 100 | 5000 |
| CMK-254 | | 4 | | | | 100 | 4000 |
| CMK-255 | | 5 | | | | 100 | 4000 |



CMK-252(red)
CMK-252X(grey)



CMK-253(orange)
CMK-253X(grey)



CMK-254(yellow)
CMK-254X(grey)



CMK-255(grey)
CMK-255X(grey)

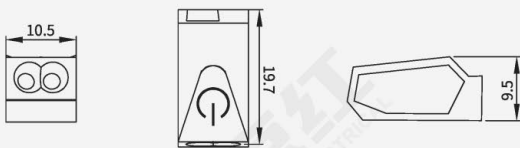

CMK-252



CMK-253

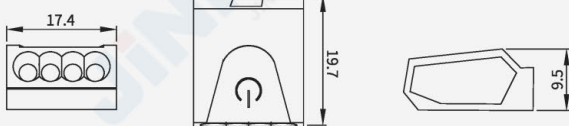

CMK-254

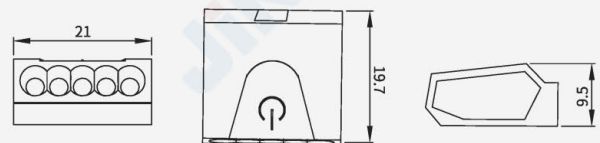









CMK-255



CMK系列快速接线端子
CMK SERIES PUSH IN QUICK-CONNECTORS

Material of connectors shell: Polycarbonate PC
 Material of actuating levers: Polyamide Pa66
 Material of conductive parts: Thinned copper
 Material of contact springs: AISI 301 stainless steel
 Rated voltage(V): 450V AC
 Rated current(A): 32A
 Connection capacity: 0.08-4mm²
 Type of electric connection: Equipotential
 Working temperature: -40°C to 105°C
 Strip length: 10mm/0.39 Inch



| Product Code | Connector type | No. of circuits | Flexible wire mm ² | Rigid wire mm ² | Volt (V) | Ampere (A) | Un  | Un  |
|--------------|---|-----------------|-------------------------------|----------------------------|----------|------------|--|--|
| CMK422-4 |  | 6 | 0.08→2.5 | 0.2→4 | 450 V | 32 A | 40 | 1600 |
| CMK422-6 |  | 8 | | | | | 30 | 1200 |
| CMK422-8 |  | 10 | | | | | 25 | 1000 |
| CMK-423-6 |  | 9 | | | | | 50 | 2000 |
| CMK-423-9 |  | 12 | | | | | 50 | 2000 |
| CMK-424-8 |  | 12 | | | | | 40 | 1600 |



CMK-422-4



CMK-422-6



CMK-422-8



CMK-423-6



CMK-423-9



CMK-424-8

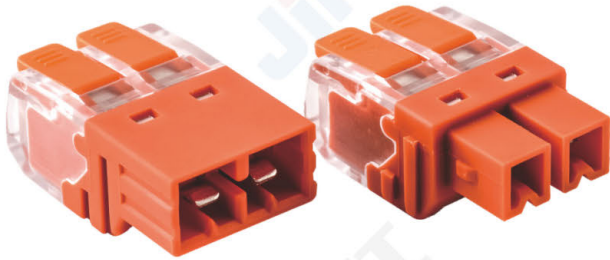

CMK系列快速接线端子
CMK SERIES PUSH IN QUICK-CONNECTORS

Material of connectors shell: Polycarbonate PC
 Material of actuating levers: Polyamide Pa66
 Material of conductive parts: Thinned copper
 Material of contact springs: AISI 301 stainless steel
 Rated voltage(V): 450V AC
 Rated current(A): 24A
 Type of electric connection: Equipotential
 Working temperature: -40°C to 105°C
 Strip length: 11mm/0.43 Inch



| Product Code | Connector type | No. of circuits | Flexible wire mm ² | Rigid wire mm ² | Volt (V) | Ampere (A) | Un | Un |
|--------------|----------------|-----------------|-------------------------------|----------------------------|----------|------------|----|------|
| CMK-642 | | 4 | 0.2-1.5 | 0.2-2.5 | 450V | 24A | 50 | 2000 |
| CMK-643 | | 6 | | | | | 40 | 1600 |
| CMK-644 | | 8 | | | | | 50 | 2000 |



CMK-651



CMK-652



CMK-653

| Product Code | Connector type | No. of circuits | Flexible wire mm ² | Rigid wire mm ² | Volt (V) | Ampere (A) | Un | Un |
|--------------|----------------|-----------------|-------------------------------|----------------------------|----------|------------|-----|------|
| CMK-651 | | 2 | 0.2-1.5 | 0.2-2.5 | 450V | 24A | 100 | 3000 |
| CMK-652 | | 4 | | | | | 50 | 2000 |
| CMK-653 | | 6 | | | | | 50 | 2000 |



CMK系列快速接线端子
CMK SERIES PUSH IN QUICK-CONNECTORS

Material of connectors shell: Transparent polycarbonate

Material of actuating levers: Polyamide pom

Material of conductive parts: Thinned copper

Material of contact springs: AISI 301 stainless steel

Rated voltage(V): 450V AC

Rated current(A): 24A

Connection capacity: 0.08-4mm²

Type of electric connection: Equipotential

Working temperature: -20°C to 85°C

Strip length: 11mm/0.43 Inch



| Product Code | Connector type | No. of circuits | Flexible wire mm ² | Color | Volt (V) | Ampere (A) | Un | Un |
|--------------|----------------|-----------------|--|--------------------------------------|----------|------------|-----|------|
| CMK211-1 | | 1-1 | 0.5→1.0 1.0→1.5 1.5→2.5 2.5→4.0 | transparent red blue yellow | 450 V | 24 A | 100 | 4000 |
| CMK211-2 | | 1-2 | 0.5→1.0 1.0→1.5 1.5→2.5 2.5→4.0 | transparent red blue yellow | | | 100 | 4000 |
| CMK212-2 | | 2-2 | 0.5→1.0 1.0→1.5 1.5→2.5 | transparent red blue | | | 50 | 2000 |
| CMK212-4 | | 2-4 | 0.5→1.0 1.0→1.5 1.5→2.5 | transparent red blue | | | 50 | 2000 |



CMK-211-1



CMK-211-2



CMK-212-2



CMK-212-4

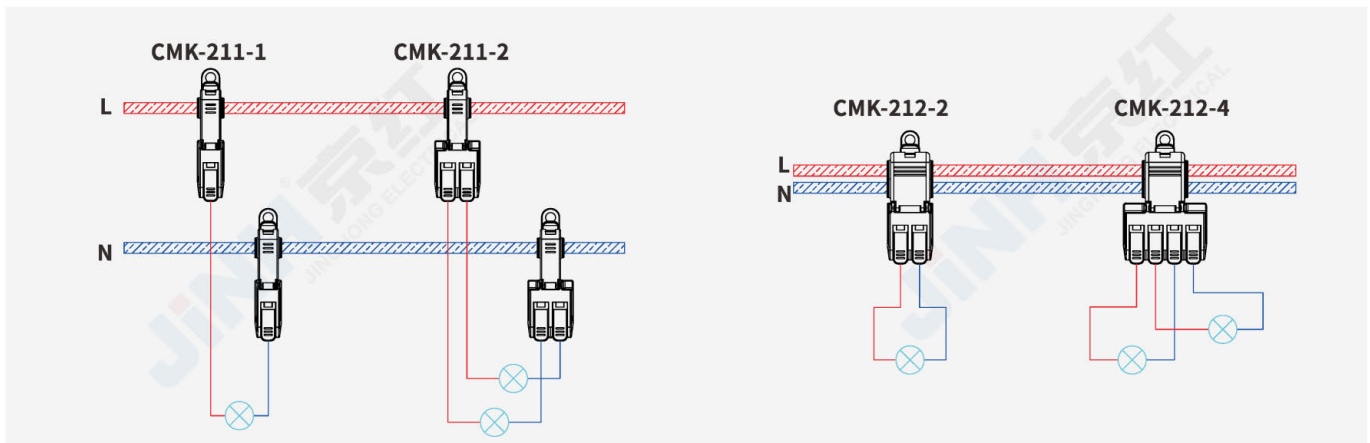







CMK系列快速接线端子
CMK SERIES PUSH IN QUICK-CONNECTORS

Material of connectors shell: Polycarbonate PC
 Material of actuating levers: Polyamide Pa66
 Material of conductive parts: Thinned copper
 Material of contact springs: AISI 301 stainless steel
 Type of electric connection: Equipotential
 Working temperature: -40°C to 105°C
 Strip length: 10mm/0.39 Inch



| Product Code | Connector type | No. of circuits | Flexible wire mm ² | Rigid wire mm ² | Volt (V) | Ampere (A) |
|--------------|--|-----------------|-------------------------------|----------------------------|----------|------------|
| CMK-462 |  | 2 | 0.5-6 | 0.5-6 | 450V | 41A |
| CMK-463 |  | 3 | | | | |

| Product Code | Connector type | No. of circuits | Flexible wire mm ² | Rigid wire mm ² | Volt (V) | Ampere (A) |
|--------------|---|-----------------|-------------------------------|----------------------------|----------|------------|
| CMK460-1P |  | 2 | 0.5-6 | 0.5-6 | 450 V | 41A |
| CMK460-2P |  | 4 | | | | |
| CMK460-3P |  | 6 | | | | |

Can be freely spliced with different numbers of digits.



| Product Code | Connector type | No. of circuits | Flexible wire mm ² | Rigid wire mm ² | Volt (V) | Ampere (A) |
|--------------|---|-----------------|-------------------------------|----------------------------|----------|------------|
| CMK470-1P |  | 2 | 0.5-6 | 0.5-6 | 450 V | 32A |

Can be freely spliced with different numbers of digits.



CMK系列快速接线端子
CMK SERIES PUSH IN QUICK-CONNECTORS

Material of connectors shell: Polycarbonate PC
 Material of actuating levers: Polyamide Pa66
 Material of conductive parts: Thinned copper
 Material of contact springs: AISI 301 stainless steel
 Rated voltage(V): 450V AC
 Rated current(A): 32A
 Connection capacity: 0.08-4mm²
 Type of electric connection: Equipotential
 Working temperature: -40°C to 105°C
 Strip length: 10mm/0.39 Inch

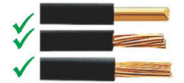
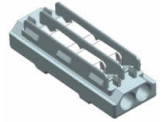

CMK-401



CMK-422



CMK-423



CMK-424



CMK-425



CMK-422C



CMK-423C



CMK-424C



CMK-425C



CMK-422A



CMK-423A

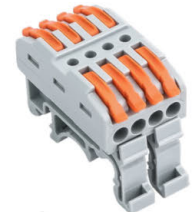

CMK-424A



CMK-425A

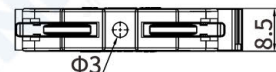
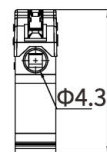
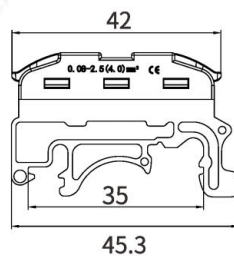

CMK系列快速接线端子
CMK SERIES PUSH IN QUICK-CONNECTORS

Material of connectors shell: Polycarbonate PC
 Material of actuating levers: Polyamide Pa66
 Material of conductive parts: Thinned copper
 Material of contact springs: AISI 301 stainless steel
 Rated voltage(V): 450V AC
 Rated current(A): 32A
 Connection capacity: 0.08-4mm²
 Type of electric connection: Equipotential
 Working temperature: -40°C to 105°C
 Strip length: 10mm/0.39 Inch

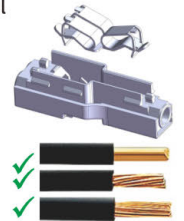

CMK-421-2



CMK-421-3



CMK-421-4



CMK-421-5



CMK-421-2C



CMK-421-3C



CMK-421-4C



CMK-421-5C



CMK-421-2A



CMK-421-3A



CMK-421-4A



CMK-421-5A



CMK-421-2K



CMK-421-3K



CMK-421-4K



CMK-421-5K



CMK系列快速接线端子
CMK SERIES PUSH IN QUICK-CONNECTORS

Material of connectors shell: Transparent polycarbonate

Material of actuating levers: Polyamide Pom

Material of conductive parts: Thinned copper

Material of contact springs: AISI 301 stainless steel

Type of electric connection: Equipotential

Working temperature: -40°C to 105°C

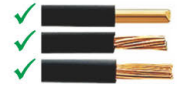

| Product Code | Connector type | Flexible wire mm ² | Conductor wire gauge range | Volt (V) | Ampere (A) | Application method | Connection range | Connection instructions (bidirectional) |
|--------------|----------------|-------------------------------|----------------------------|----------|------------|--------------------|-----------------------|---|
| CMK213-1P | | 0.3-0.5 | Ø1.5-Ø2.1 | 300V | 6A | Plug-in Connection | No stripping of wires | One in one out |
| CMK213-2P | | | | | | | | Two in two out |
| CMK213-3P | | | | | | | | Three in three out |



| Product Code | Connector type | No. of circuits | Rigid wire mm ² | Flexible wire mm ² | Volt (V) | Ampere (A) | Un | Un |
|--------------|----------------|-----------------|----------------------------|-------------------------------|----------|------------|-----|------|
| CMK-101 | | 1-1 | 0.5→2.5 | 1.0→2.5 | 450 V | 24 A | 100 | 6000 |
| CMK-112 | | 1-2 | | | | | 100 | 4000 |
| CMK-201 | | 1-1 | | | | | 50 | 2000 |

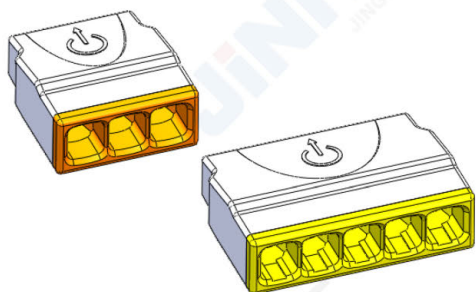

CMK系列快速接线端子
CMK SERIES PUSH IN QUICK-CONNECTORS

Material of connectors shell: Transparent polycarbonate

Material of conductive parts: Thinned copper

Material of contact springs: AISI 301 stainless steel

Type of electric connection: Equipotential

Working temperature: -40°C to 85°C

Strip length: 1mm/0.51 Inch



| Product Code | Connector type | No. of circuits | Rigid wire mm ² | Volt (V) | Ampere (A) | Un | Un |
|--------------|----------------|-----------------|----------------------------|----------|------------|-----|------|
| CMK-242 | | 2 | 0.75-4 | 450 V | 32A | 150 | 9000 |
| CMK-243 | | 3 | | | | 100 | 6000 |
| CMK-244 | | 4 | | | | 100 | 6000 |
| CMK-245 | | 5 | | | | 100 | 6000 |
| CMK-246 | | 6 | | | | 50 | 3000 |
| CMK-248 | | 8 | | | | 50 | 3000 |



CMK-242

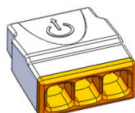

CMK-243

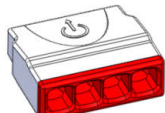

CMK-244

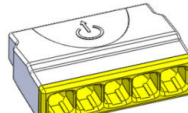

CMK-245

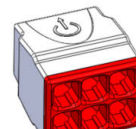

CMK-246



CMK-248

| Product Code | Connector type | No. of circuits | Rigid wire mm ² | Volt (V) | Ampere (A) |
|--------------|----------------|-----------------|----------------------------|----------|------------|
| CMK-173 | | 3 | 1.5-6 | 450V | 41A |
| CMK-174 | | 4 | | | |

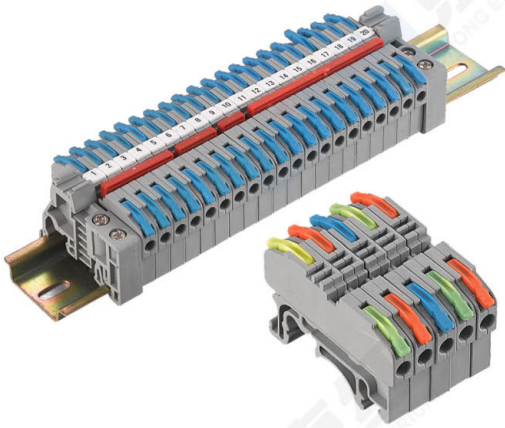

CMK系列快速接线端子
CMK SERIES PUSH IN QUICK-CONNECTORS

Material of connectors shell: Polyamide Pa66
 Material of actuating levers: Polyamide Pa66
 Material of conductive parts: Thinned copper
 Material of contact springs: AISI 301 stainless steel
 Rated voltage(V): 450V AC
 Rated current(A): 32A
 Connection capacity: 0.08-4mm²
 Type of electric connection: Equipotential
 Working temperature: -20°C to 85°C
 Strip length: 10mm/0.39 Inch



| Product Code | Connector type | No. of circuits | Flexible wire mm ² | Rigid wire mm ² | Volt (V) | Ampere (A) | Un | Un |
|--------------|----------------|-----------------|-------------------------------|----------------------------|----------|------------|----|------|
| CMK-420 | | 2 | 0.08→2.5 | 0.2→4 | 450 V | 24 A | 50 | 2000 |
| CMK-420-4 | | 2 | 0.2→4 | 0.2→4 | 450 V | 32 A | 50 | 2000 |
| CMK-420-6 | | 2 | 0.5→6 | 0.5→6 | 450 V | 41 A | 50 | 2000 |



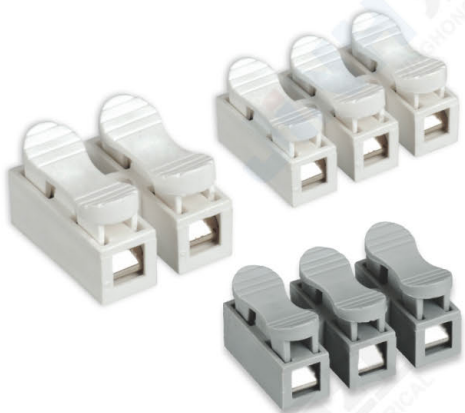

CMK系列快速接线端子
CMK SERIES PUSH IN QUICK-CONNECTORS



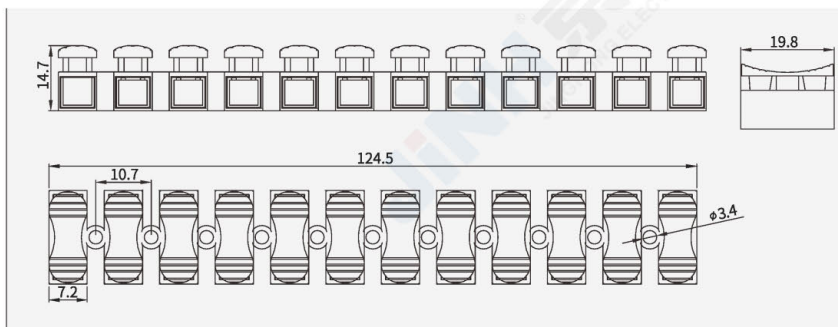
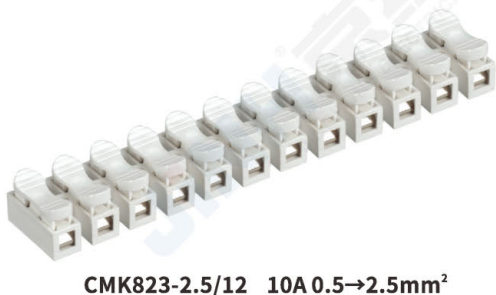
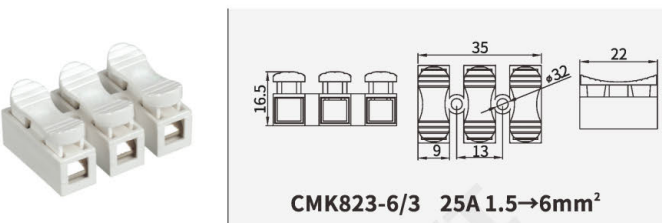
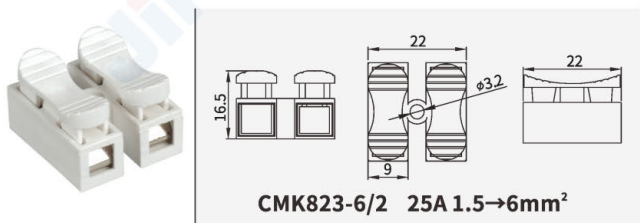
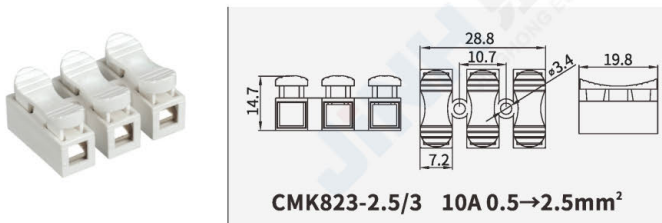
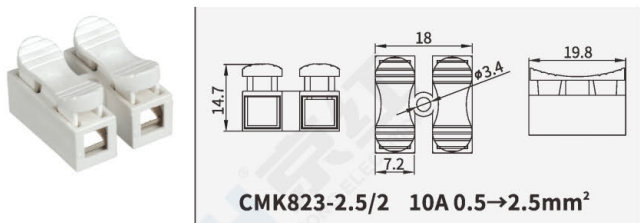
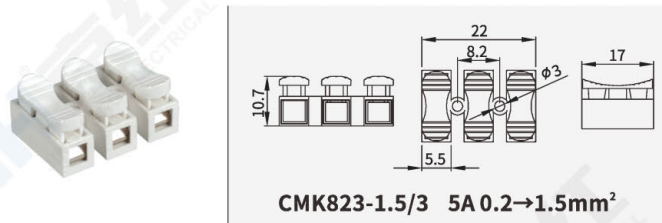
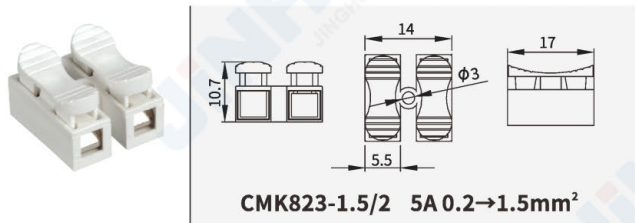

Material of connectors shell: Polypropylene
 Material of conductive parts: Thinned copper
 Material of contact springs: AISI 301 stainless steel
 Rated voltage(V): 450V AC
 Rated current(A): 5A,10A,25A
 Connection capacity: 0.2-6mm²
 Type of electric connection: Equipotential
 Working temperature: -20°C to 90°C
 Strip length: 11mm/0.43 Inch

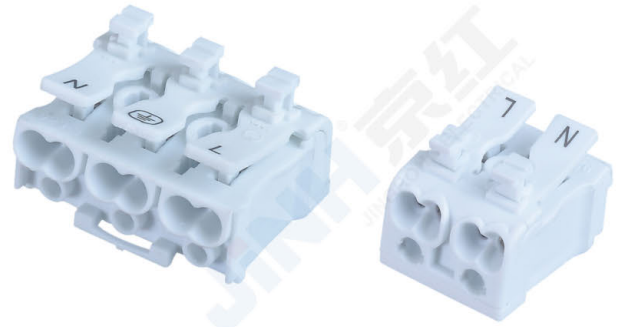

CMK 系列快速接线端子
CMK SERIES PUSH IN QUICK-CONNECTORS

Electrical parameter: 450V/24A
Stripping length : 8-10mm/0.39in
Connection wire mm: 0.75→2.5mm²



| Product Code | Connector Type | No. of circuits | Volt (V) | Ampere (A) | Connection wire mm ² | Specification size (L×W×H) |
|--------------|---|-----------------|----------|------------|---------------------------------|----------------------------|
| CMK923-2 |  | 2P | 450 | 24 | 0.75→2.5 | 19.8×25.5×17.9mm |
| CMK923-3 |  | 3P | | | | 29.9×25.5×17.9mm |
| CMK923-4 |  | 4P | | | | 40.1×25.5×17.9mm |
| CMK923-5 |  | 5P | | | | 50.2×25.5×17.9mm |



CMK923-2P



CMK923-3P



CMK923-4P

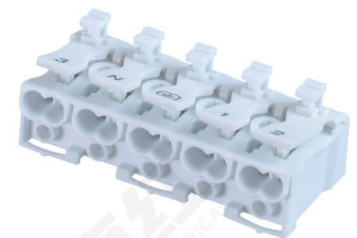

CMK923-5P



earth